

# Tuyaux Articulés 1/4" - Ø 6,35

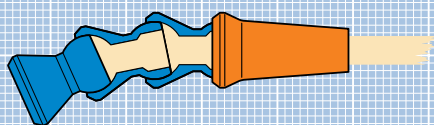

**Segment 1/4" PETIT DEBIT**  
 Ø intérieur : 6.35 mm  
 Ø extérieur : 16.25 mm  
 Longueur utile : 14.7 mm  
 Rayon de courbure mini : R 32 mm  
**Pression maxi : 3.5 Bar** (circuit fermé)  
 Débit : 15 litres / minute  
 Température d'utilisation maxi : 80°C

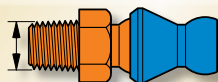
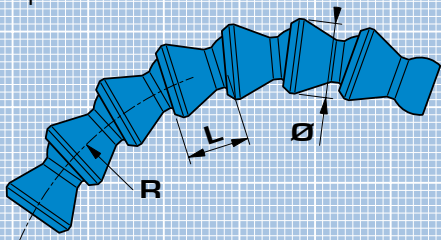

Filetages des raccords	NPT		BSP T	
	Filet à 60°		Filet à 55°	
	Ø - filets/pouce		Ø - filets/pouce	
1/8"	10 mm	27	10 mm	28
1/4"	13,5 mm	18	13,2 mm	19

## Segments Longs

**Segment long, 90 mm** Réf.

**Segment long avec anneau** Réf. 41-475  
 Pochette de 4

**Segment sans anneau** Réf. 41-476  
 Pochette de 4  
 Sachet de 20 49-445

**Segment coudé à 90°** Réf.

**Segment coudé avec anneau** Réf. 40-474  
 Pochette de 4

**Segment sans anneau** Réf. 41-491  
 Pochette de 4 49-457  
 Sachet de 20

**Anneau de rigidité** Réf. 41-477  
 Pochette de 4 49-446  
 Sachet de 20



Détails page 18



## Equipement de base

Raccord 1/4" NPT 40-462  
 Raccord 1/4" BSPT 40-464  
 Longueur 325 mm  
 1 raccord 1/4"  
 1 buse Ø 3,2  
 20 segments

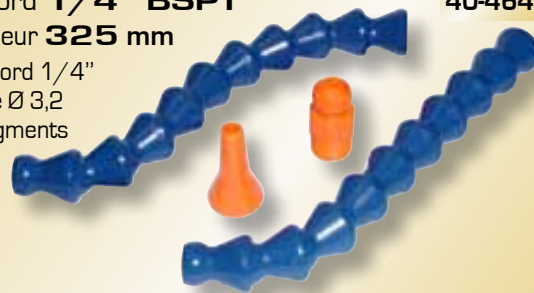

Nouveau

## Equipement standard

Raccord 1/8" et 1/4" NPT 40-413  
 Longueur 325 mm  
 2 raccords : 1/4" et 1/8"  
 3 buses : Ø 1,6 à 6,35  
 20 segments

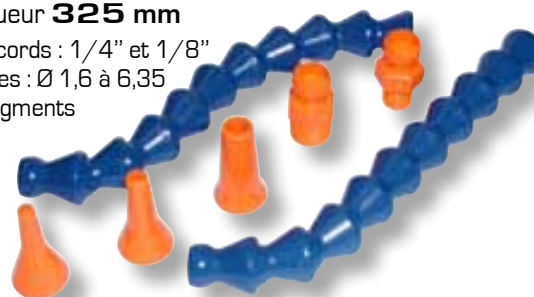

## Equipement complet

Robinet mâle 1/4" NPT 40-460  
 Longueur 340 mm  
 1 robinet mâle 1/4"  
 3 buses Ø 1,6 à 6,35  
 1 buse plate 25  
 20 segments

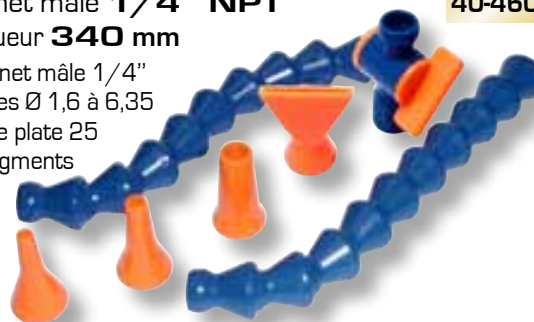

## Segments Standards

**Segment 1/4"** Réf. 41-401  
 285 mm (20 pièces)  
 1 mètre (70 pièces) 41-400  
 7,5 mètres (530 pièces) 49-420  
 15 mètres (1060 pièces) 49-421

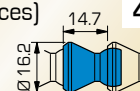

Rotule 1/4

## Assortiment de segments longs

Détails page 13



# Tuyaux Articulés 1/4" - Ø 6,35

## Raccords filetés et Manchons taraudés

### Raccord fileté

1/8" NPT

Pochette de 4  
Sachet de 50



Réf.



41-405  
49-425

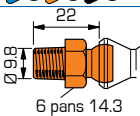

1/4" NPT

Pochette de 4  
Sachet de 50



41-406  
49-426

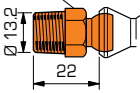

1/8" BSPT (Gaz)

Pochette de 4  
Sachet de 50



41-417  
49-437

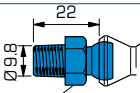

1/4" BSPT (Gaz)

Pochette de 4  
Sachet de 50



41-418  
49-438

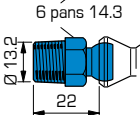

### Manchon taraudé

1/8" NPT vers rotule femelle

Pochette de 4  
Sachet de 20



Réf.



41-411  
49-431

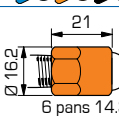

1/8" NPT vers 1/8" NPT

Pochette de 4



40-656

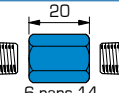

1/4" NPT vers 1/4" NPT

Pochette de 4



40-657

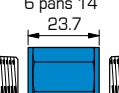

### Réducteur

1/4" vers 1/8" NPT

Pochette de 4



40-655

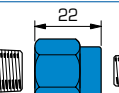

## Robinetts et Segments spéciaux

### Robinet

1/4" NPT mâle

Fileté  
Pochette de 2  
Sachet de 10



Réf.



21-192  
29-452

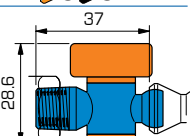

1/4" NPT femelle

Taraudé  
Pochette de 2  
Sachet de 10



21-193  
29-453

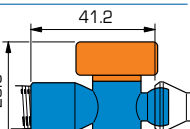

### En ligne

Pochette de 2  
Sachet de 10



21-194  
29-454

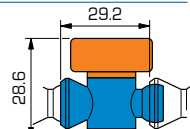

### Métallique

1/4" BSPT  
vers 1/4" BSPT  
1 Robinet



40-310

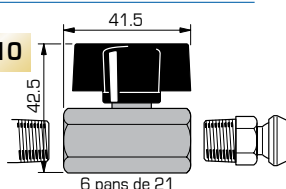

### Segment à jet central

1 trou Ø 2 mm

Pochette de 4



Réf.



41-478

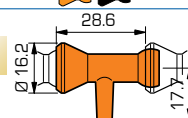

### Bouchon obturateur

Pochette de 4



Réf.

41-480



### Cirque

Pochette comprenant :  
15 Segments  
1 Bouchon  
Longueur : 446 mm  
Ø mini inter : 92 mm



41-479

## KOPAL

### Adaptateur Cylindrique

Court

Réf.

Adaptateur Ø 15

Pochette de 4  
Sachet de 20



41-492  
49-458

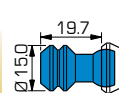

Spécial Haas

Pochette de 4  
Sachet de 20

41-494  
49-460

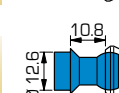

### Valve anti-retour

Pochette de 2  
Sachet de 10

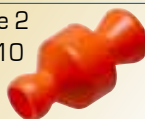

Réf.



21-191  
29-451

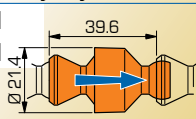

Stoppe l'écoulement de liquide lorsque la pompe est arrêtée. Le liquide est immédiatement disponible et réduit le fonctionnement à sec des outils. Débit minimum garanti : 95%

### Assortiment Adaptateur 1/4"

pour porte-outils avec trous Ø 15  
type Haas

40-476  
40-475

4 Adaptateur court, 4 Adaptateur long  
2 Buse 11mm 5 trous, 2 Buse 11mm  
2 Buse d'équerre Ø 3.2 et Ø 6.35  
2 Buse ronde Ø 3.2 et Ø 6.35  
2 Buse plate 25mm à jet concentré  
4 Anneau de rigidité, 8 x Segment standard  
1 Pince d'assemblage 1/4"



Long, 50.8 mm

Adaptateur Ø 15

Pochette de 4  
Sachet de 20

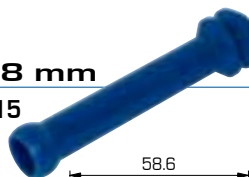

Réf.

41-493  
49-459



Spécial Haas

Pochette de 4  
Sachet de 20

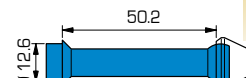

41-495  
49-461





KOPAL 05

ARROSAIGE

# Tuyaux Articulés 1/4" - Ø 6,35

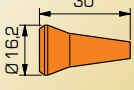
## Buses rondes

Buse ronde	Réf.	
1 trou Ø 1,6 mm Pochette de 4 Sachet de 50	<b>41-402</b> <b>49-422</b>	
1 trou Ø 3,2 mm Pochette de 4 Sachet de 50	<b>41-403</b> <b>49-423</b>	
1 trou Ø 6,35 mm Pochette de 4 Sachet de 50	<b>41-404</b> <b>49-424</b>	

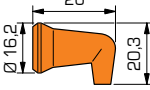
Buse d'équerre	Réf.	
1 trou Ø 1,6 mm Pochette de 4 Sachet de 20	<b>41-470</b> <b>49-439</b>	
1 trou Ø 3,2 mm Pochette de 4 Sachet de 20	<b>41-471</b> <b>49-440</b>	
1 trou Ø 6,35 mm Pochette de 4 Sachet de 20	<b>41-472</b> <b>49-441</b>	

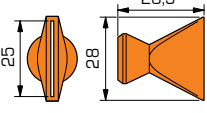
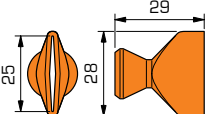

## Buses plates

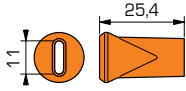
Buse plate 25 x 0,8 mm	Réf.	
Pochette de 2 Sachet de 20	<b>41-407</b> <b>49-427</b>	
<b>Buse 25 mm à Jet Concentré</b>	<b>41-489</b> <b>49-456</b>	
Pochette de 2 Sachet de 20		

Buse plate 11 mm	Réf.	
11 x 1 mm Pochette de 4 Sachet de 20	<b>41-483</b> <b>49-451</b>	
11 x 1,5 mm Pochette de 4 Sachet de 20	<b>41-484</b> <b>49-452</b>	

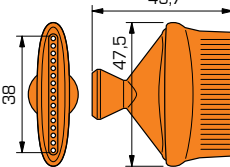
## Buses multi-jets

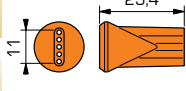
Buse orientable	Réf.	
16 trous Ø 1 mm L : 38 mm Pochette de 2 Sachet de 20	<b>41-481</b> <b>49-449</b>	
16 trous Ø 1,5 mm L : 38 mm Pochette de 2 Sachet de 20	<b>41-482</b> <b>49-450</b>	
20 trous Ø 1,9 mm L : 62 mm Pochette de 2 Sachet de 20	<b>41-488</b> <b>49-455</b>	

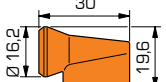
Buse 11 mm	Réf.	
7 trous Ø 1 mm Pochette de 4 Sachet de 20	<b>41-486</b> <b>49-454</b>	
5 trous Ø 1,5 mm Pochette de 4 Sachet de 20	<b>41-485</b> <b>49-453</b>	
<b>Buse d'équerre</b>	Réf.	
6 trous Ø 2,5 mm Pochette de 2 Sachet de 20	<b>41-473</b> <b>49-442</b>	

## Assortiments de Buses

Assortiment de 16 Buses	Réf.	
Pochette	<b>41-490</b>	
3 Buses rondes : Ø 1,6 - 3,2 - 6,35		
3 Buses d'équerres : Ø 1,6 - 3,2 - 6,35		
4 Buses plates : L 25 x 0,8 - 25 à jet concentré L 11 x 1 - L 11 x 1,5		
5 Buses multi-jets : 16 trous Ø 1 - 16 trous Ø 1,5 20 trous Ø 1,9 7 trous Ø 1 - 5 trous Ø 1,5		
1 Buse d'équerre multi-jet : 6 trous Ø 2,5		

Assortiment de 4 Buses d'équerres	Réf.
Pochette de 4 buses Ø 1,6 - 3,2 - 6,35 - 6 trous Ø 2,5	<b>41-474</b>



## Pinces d'assemblage

1 Pince pour Loc-line 1/4"	<b>78-001</b>
2 Pinces : 1 en 1/4" et 1 en 1/2"	<b>78-003</b>

Utilisez le plus souvent possible pour assembler et déboîter le tuyau en toute sécurité.





# Tuyaux Articulés 1/4" - Ø 6,35

## Distributeurs et éléments de liaison

### Élément de liaison

Réf.  

**Dérivation en Y**  
1/4" vers 1/4"  
Pochette de 2  
Sachet de 20



**41-408**  
**49-428**

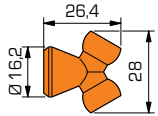

**Manchon double**  
**femelle**  
Pochette de 4  
Sachet de 20



**41-409**  
**49-429**

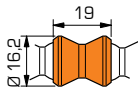

**Coude mâle-femelle**  
1/4" vers 1/4"  
Pochette de 2  
Sachet de 20



**41-415**  
**49-435**

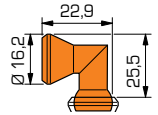

**Dérivation en T**  
1/4" vers 1/4"  
Pochette de 2  
Sachet de 20



**41-416**  
**49-436**

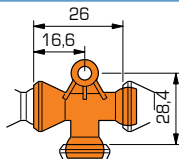

### Support pour Manifold

Pochette de 2

**21-195**

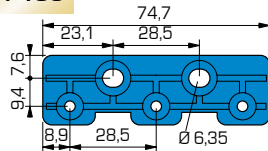

**LOC-LINE noir disponible**  
sur commande 

### Distributeur standard

Réf.

#### Manifold

**21-199**

1 support avec vis  
3 dérivation en té  
1 coude  
mâle-femelle



### Distributeur complet

Réf.

#### Manifold

**21-198**

1 support avec vis  
3 dérivation en té  
1 coude  
5 robinets en ligne

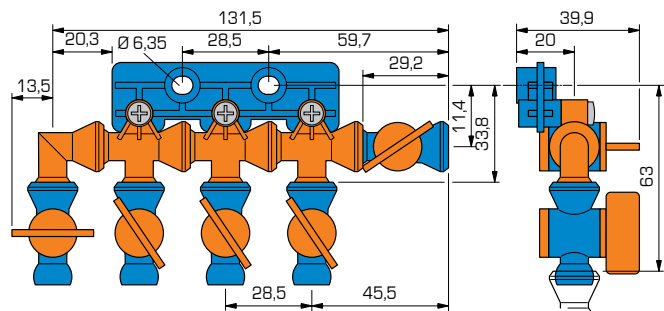

## Distributeurs métalliques magnétiques

### Support magnétique

1 corps aluminium anodisé  
Ø 54 mm avec 4 sorties  
1/4" NPT femelle  
1 raccord tube  
3 bouchons 1/4" NPT

*Plus de modèles page 15*

**40-305**

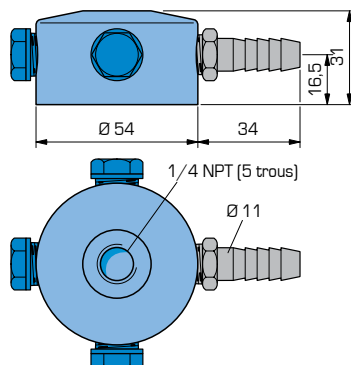

### Support magnétique équipé

comprenant :

1 support 40-305

2 équipements 40-460

**40-306**



**LOC-LINE®**

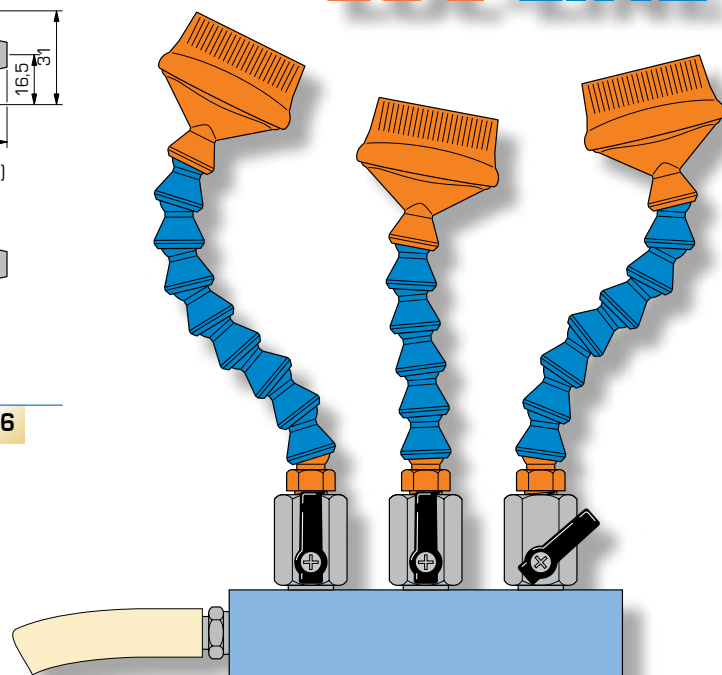

**KOPAL 07**

**ARROSAGE**